



Arlington®

# ADJUSTABLE SLIDERBAR™

SLIDERBAR • BOXES • SLIDERBAR KITS

Patent pending

Here's the easy, NEAT way to mount single or two gang boxes between wood or metal studs.

Arlington's steel SliderBar™ looks great and **saves about 20 minutes per box** over cutting, nailing and placing extra 2x4s.



**SAVE 20 MINUTES PER BOX**



SL2B18

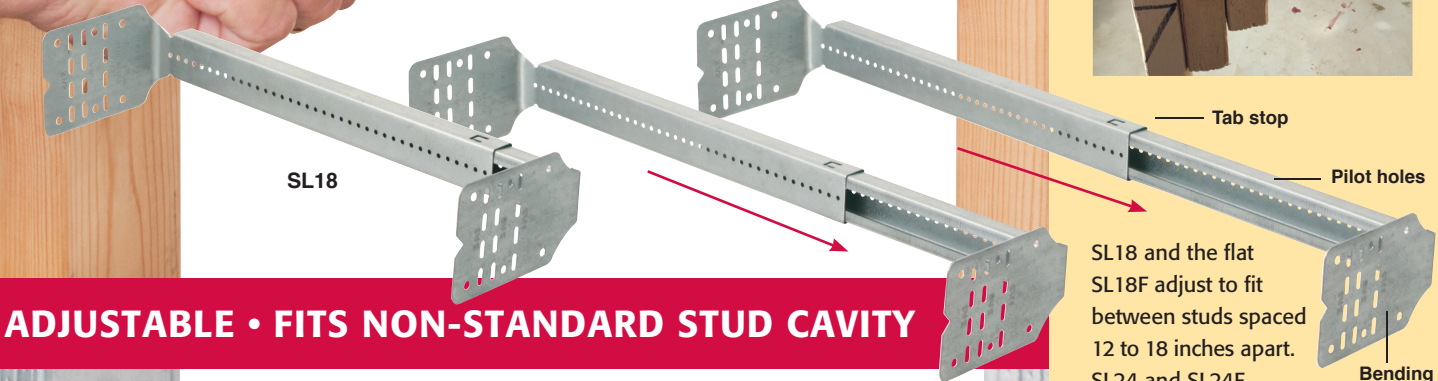

SL18

Tab stop

Pilot holes

Bending guides

**ADJUSTABLE • FITS NON-STANDARD STUD CAVITY**

SL18 and the flat SL18F adjust to fit between studs spaced 12 to 18 inches apart.

SL24 and SL24F fit 15 to 24 inch spacing.

All allow installers to **position one or multiple boxes** where needed, on ONE or BOTH sides of SliderBar ...even facing opposite directions on a 2x6.

**Punched pilot holes** on each side of SliderBar make for easy attachment of box(es).

An **interlocking tab stop** prevents accidental disassembly.

**Bending guides on bracket ends** assure proper positioning on studs.

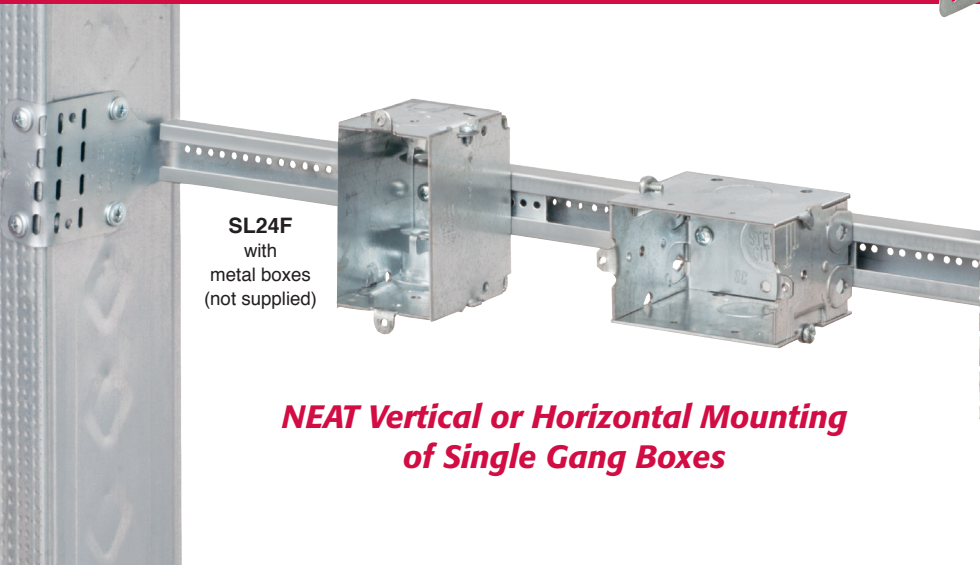

SL24F with metal boxes (not supplied)

**NEAT Vertical or Horizontal Mounting of Single Gang Boxes**

**SLIDERBAR... for SINGLE and TWO GANG METAL and PLASTIC BOXES**

# SLIDERBAR™

## WITH PRE-BENT BRACKETS

**SAVES TIME... ABOUT 20 MINUTES PER BOX!**

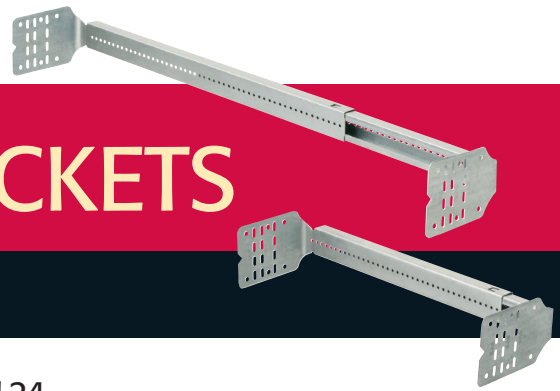

SL18 and SL24 adjustable SliderBar with PRE-BENT brackets – and single and two gang plastic boxes are sold separately.

Also available in kit form, **SliderBar Box Kits** include an SL18 or SL24 SliderBar with a single or two gang plastic box.

Our plastic boxes are rated for non-metallic sheathed cable. And come with molded screw bosses for easy attachment to SliderBar.

### EASY TO INSTALL SL18, SL24

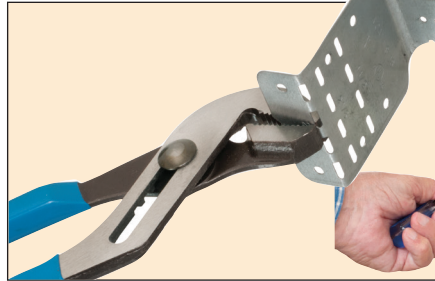

Bend bracket ends at 2-1/2" mark for use with 1/2" or 5/8" thick wall board. Ends can also be bent 90° or backwards (180°) as needed for inside mounting.

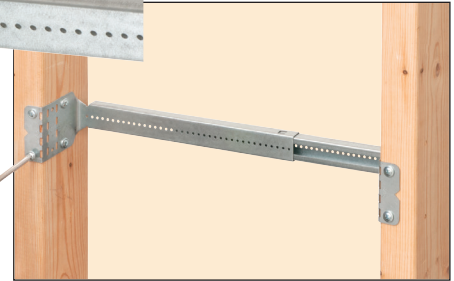

Determine placement of SliderBar on metal or wood stud. Fasten SliderBar to studs with screws or nails.

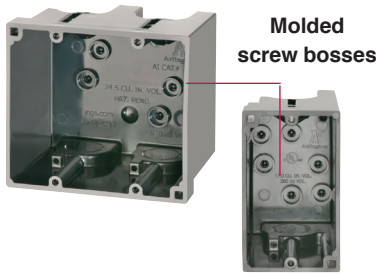

Molded screw bosses

Metal boxes mounted on SliderBar are rated for non-metallic as well as MC, AC and Flexible Metal Clad cable.

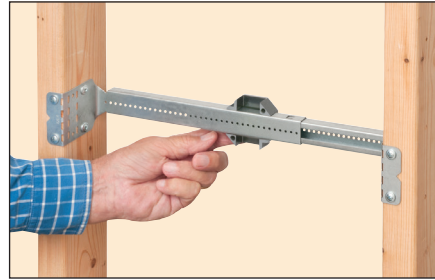

**OPTION** Use supplied slider clip(s) to mount box(es) on SliderBar.

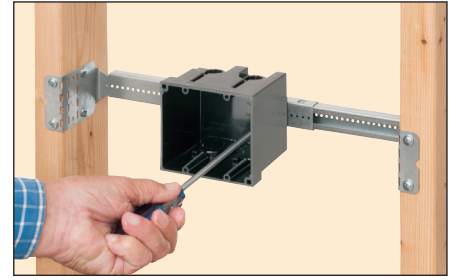

Install plastic or metal box(es) on SliderBar with #8 sheet metal screws.

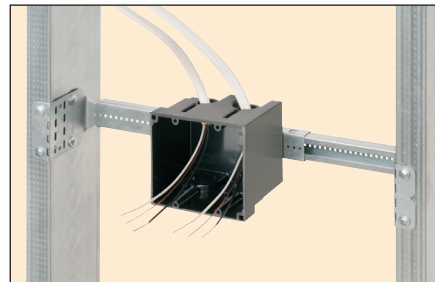
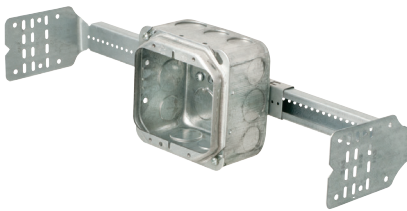

Pull wires.

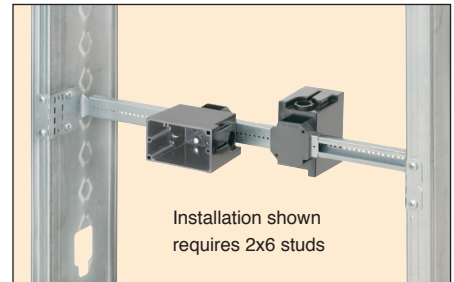

Installation shown requires 2x6 studs

Single gang box mounts vertically or horizontally. Pilot holes on both sides of SliderBar allow the installation of boxes in opposing directions.



**Adjustable SLIDERBAR...**

**Installs Plastic or Metal Boxes between Wood or Metal Studs**



**Arlington®**

# WITH FLAT BRACKETS

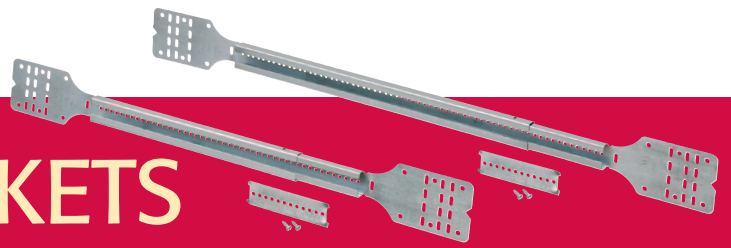

**LISTED • SAVES TIME • INCLUDES BOX MOUNTING BRACKET**

For added convenience, 18 and 24 inch adjustable SliderBar with *FLAT* brackets – come with a steel mounting bracket for installing most metal boxes, as well as our plastic SLB101 and SLB102 boxes, on the bar.

The bracket works with almost any metal box. And if you need to add *another* box to SliderBar, use our SL18BKT mounting bracket.

- Metal boxes mounted on SliderBar are rated for non-metallic as well as MC, AC and Flexible Metal Clad cable
- Holds up to a 6 lb fixture or receptacle in a ceiling installation

## FLAT SLIDERBAR INSTALLATION

Attach mounting bracket to metal box with supplied screws.

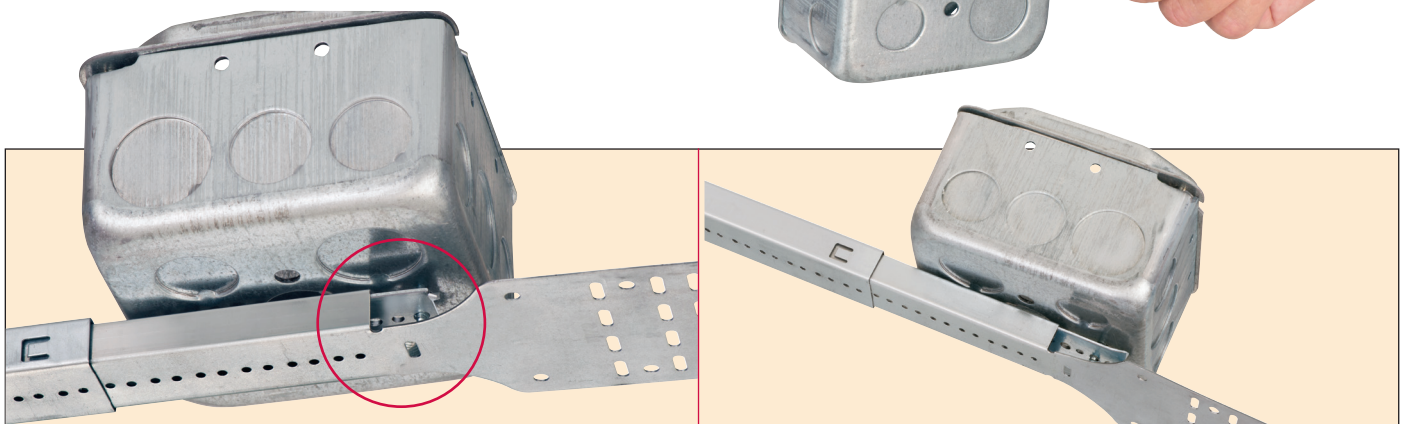

Slide the box-bracket assembly into SliderBar channel BEFORE bending SliderBar bracket ends.

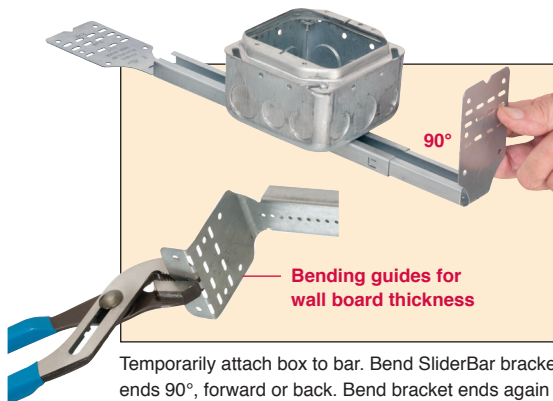

Temporarily attach box to bar. Bend SliderBar bracket ends 90°, forward or back. Bend bracket ends again at the mark for desired wall board thickness.

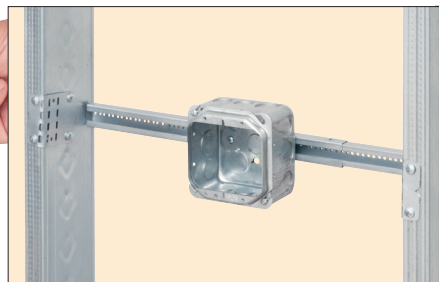

Mount SliderBar on studs with #8 x 1/2" screws. Position box on bar. Tighten screws inside box.

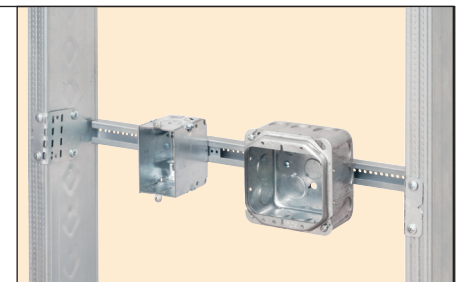

Use a **SL18BKT** mounting bracket to add another metal box to SliderBar.

800.233.4717

[www.aifittings.com](http://www.aifittings.com)

EMAIL [sales@aifittings.com](mailto:sales@aifittings.com)

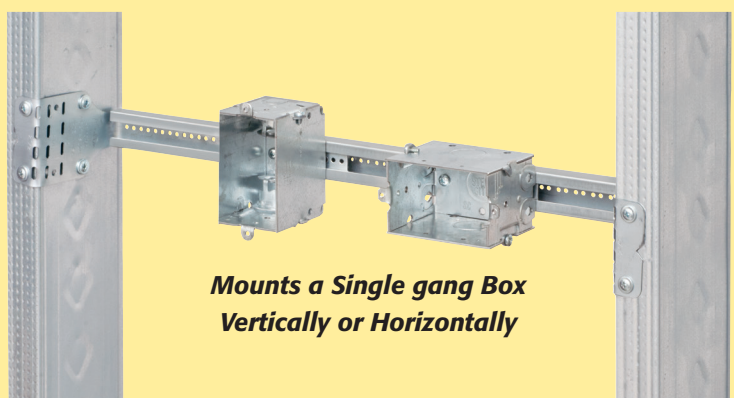

**Mounts a Single gang Box Vertically or Horizontally**

# SLIDERBAR™

## PRE-BENT BRACKET

CATALOG NUMBER	UPC/DCI/NAED MFG. #018997	DESCRIPTION SLIDERBAR • BOXES • KITS	UNIT PKG	STD PKG
SL18	00929	<b>18" SLIDERBAR</b> Adjustable. Fits between studs, 12" to 18" wide	25	25
SL24 •	00920	<b>24" SLIDERBAR</b> Adjustable. Fits between studs, 15" to 24" wide	25	25
<b>BOX ONLY</b>				
SLB101*	00930	<b>Single Gang Plastic Box</b> Mounts vertically or horizontally on SLIDERBAR	25	25
SLB102*	00931	<b>Two Gang Plastic Box</b>	10	10
<b>SLIDERBAR KITS</b>				
SL1B18* KIT	00932	SL18 SLIDERBAR, Single Gang Plastic Box	10	10
SL2B18* KIT	00933	SL18 SLIDERBAR, Two Gang Plastic Box	10	10
SL1B24* • KIT	00921	SL24 SLIDERBAR, Single Gang Plastic Box	10	10
SL2B24* • KIT	00922	SL24 SLIDERBAR, Two Gang Plastic Box	10	10

**Boxes include** installed NM cable connector(s), (2) #8 x 3/4" screws, slider clip.

**Kits include** SliderBar, plastic box with installed NM cable connector, #8 x 3/4" screws for box-to-bar attachment, slider clip.

• UL Listed only

\* Add suffix 'GC' for orders in Canada, ie: SLB101GC

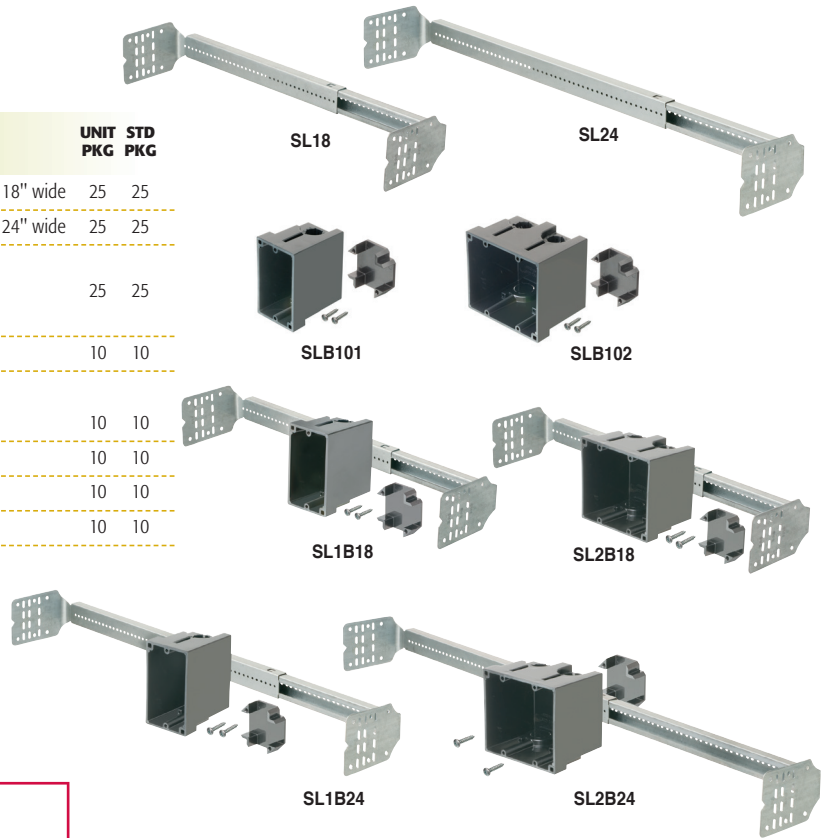

### SLIDERBAR BOX RATINGS

**PLASTIC BOXES** are rated for non-metallic sheathed cable.

If using a **METAL BOX** SliderBar Kits are also rated for MC, AC and FMC. (Metal Boxes not included)

## FLAT BRACKET

CATALOG NUMBER	UPC/DCI/NAED MFG. #018997	DESCRIPTION FLAT SLIDERBAR	UNIT PKG	STD PKG
SL18F	15902	<b>18" FLAT SLIDERBAR</b> Fits between studs, 12" to 18" wide	25	25
SL24F •	15903	<b>24" FLAT SLIDERBAR</b> Fits between studs, 15" to 24" wide	25	25
SL18BKT	15901	<b>Steel Mounting Bracket</b> , (2) #8 x 1/2" screws	50/bag	50/bag

SL18F, SL24F include flat SliderBar, steel mounting bracket, (2) #8 x 1/2" screws

• UL Listed only

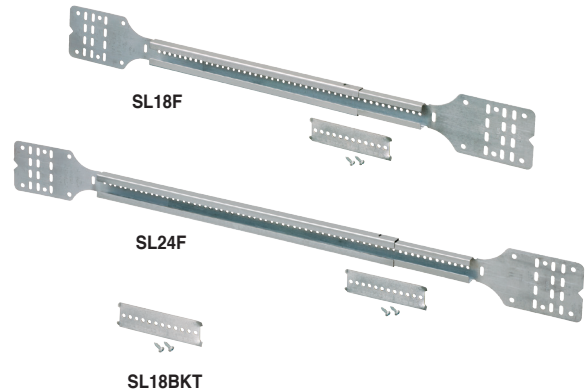

Patent pending

Distributed by



**Arlington®**

1 Stauffer Industrial Park. Scranton, PA 18517

800.233.4717 • EMAIL [sales@aifittings.com](mailto:sales@aifittings.com)

[www.aifittings.com](http://www.aifittings.com)